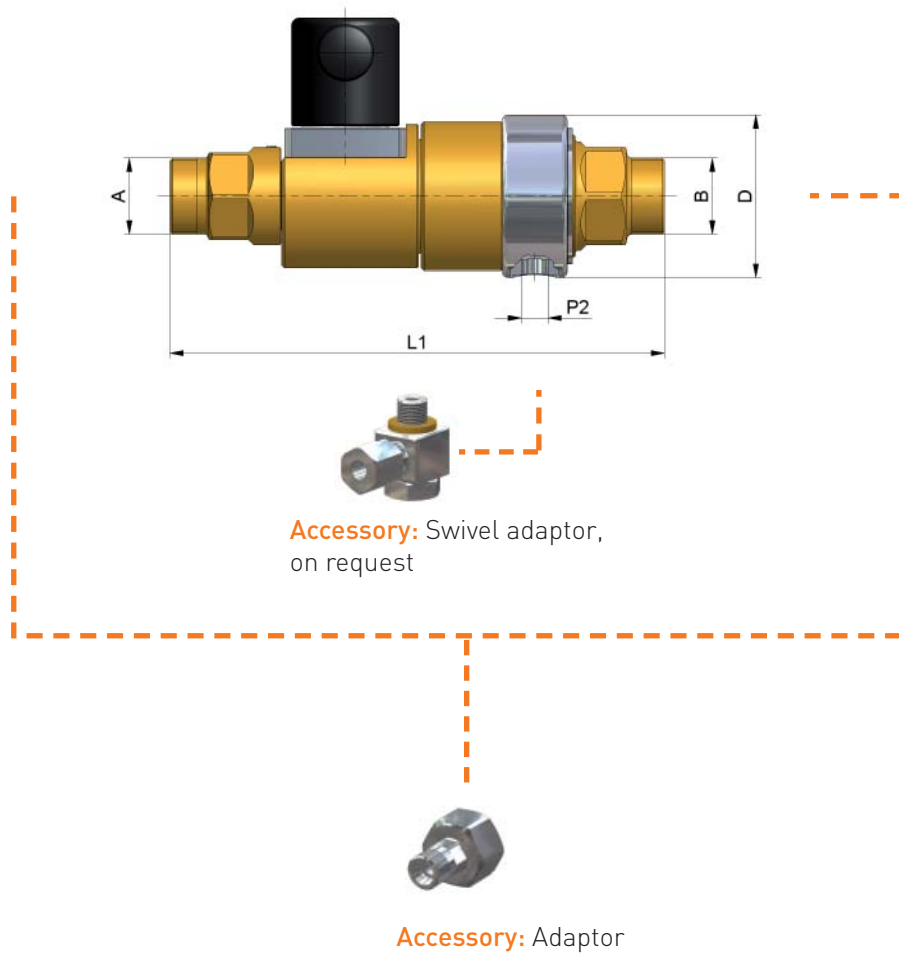

TV17 ACCESSORIES

ACCESSORIES | for *manual* actuation

TV17 ACCESSORIES | Adaptors

OVERVIEW | Adaptors

For connections to other components WEH can offer an extensive range of adaptors. These adaptors simplify valve, hose, pipework and sensor installation.



Fig. 1: Adaptors

Adaptors

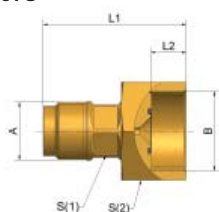

with plain-o-ring

DN (mm)	Bore	Port A	inlet B	L1 (mm)	L2 (mm)	A/F	Part No.
8	3	M20x1.5 external thread	M28x1.5 internal thread	55.5	10.5	18	C1-84453
12	3	M24x2.0 external thread	UNF 1 3/8" - 12 internal thread	59.5	14.5	22	C1-76167

Adaptors

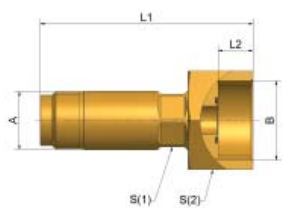

with plain-o-ring

DN (mm)	Bore	Port A	inlet B	L1 (mm)	L2 (mm)	A/F	Part No.
8	8	M20x1.5 external thread	M28x1.5 internal thread	84.5	10.5	18	C1-84458
12	12	M24x2.0 external thread	UNF 1 3/8" - 12 internal thread	88.5	14.5	22	C1-75271
8	8	M20x1.5 external thread	M28x1.5 internal thread	55.5	10.5	18	C1-84463
12	12	M24x2.0 external thread	UNF 1 3/8" - 12 internal thread	59.5	14.5	22	C1-75266

Adaptors

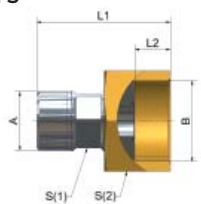

Ermeto Ø 12

DN (mm)	Bore	Port A	inlet B	L1 (mm)	L2 (mm)	A/F	Part No.
8	8	M20x1.5 external thread	M28x1.5 internal thread	50.5	10.5	18	C1-84474
12	12	M24x1.5 24° external thread	UNF 1 3/8" - 12 internal thread	54.5	14.5	22	C1-75267

TV17 ACCESSORY | Adaptors to fit all TV17 valves

Adaptors

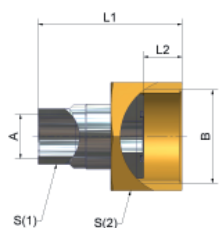

with plain-o-ring

DN (mm)	Port A	inlet B	L1 (mm)	L2 (mm)	A/F	Part No.
12	G3/8" internal thread	UNF 1 3/8" - 12 internal thread	54.5	14.5	21	C1-78440

Adaptors

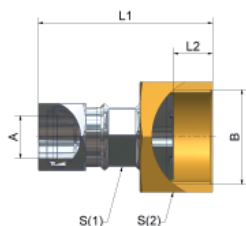

with tube fitting

DN (mm)	Port A	inlet B	L1 (mm)	L2 (mm)	A/F	Part No.
8	Tube Ø 12	UNF 3/4" - 20 internal thread	60	10.5	18	C1-84478
12	Tube Ø 16	UNF 1 3/8" - 12 internal thread	64.6	14.5	22	C1-75940

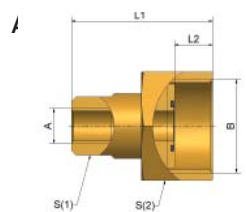

with plain-o-ring

DN (mm)	Port A	inlet B	L1 (mm)	L2 (mm)	A/F	Part No.
8	G1/4" internal thread	M28x1.5 internal thread	35.5	10.5	18	C1-51571
12	G1/4" internal thread	UNF 1 3/8" - 12 internal thread	53.5	14.5	22	C1-76974