

Level switch NS 10 / NS 25 ..AM

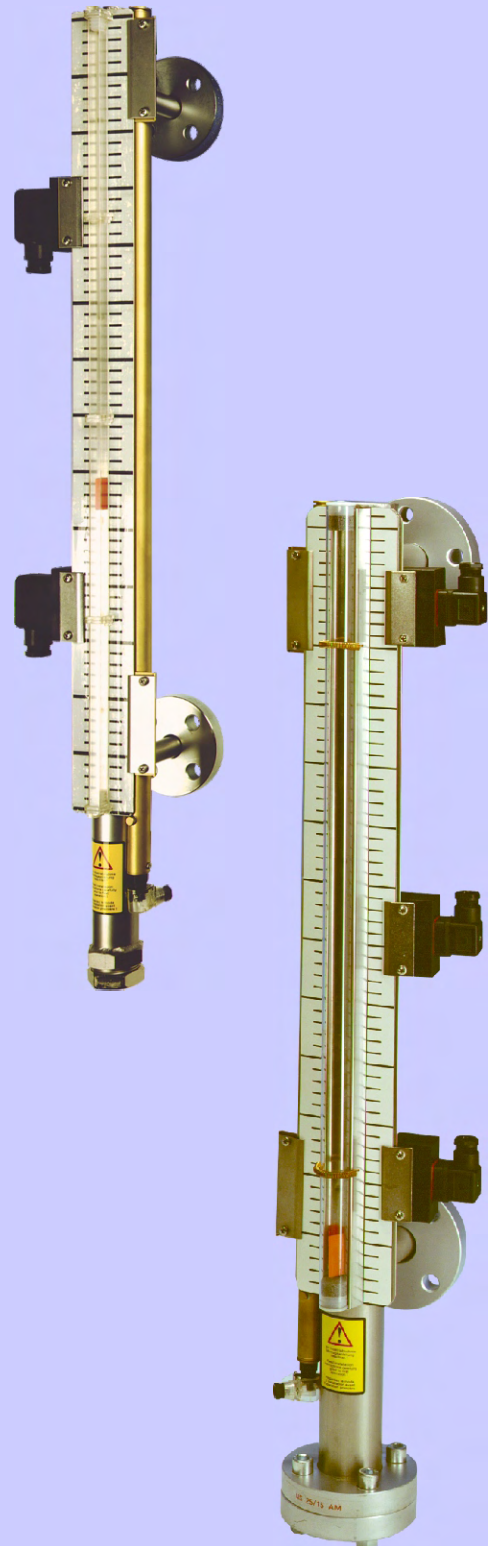

Level switch NS for external installation

- visual and electric surveillance of liquid level
- pressure range up to 25 bar
- lengths up to 5000 mm
- adjustable level contacts
- optional analogue output 4-20mA
- visual indication with scale
- robust design meets industrial standards
- float with dynamic buoyancy
- specials upon request

Technical data

NS 10 ..-AM

Basic unit

max. operating pressure	10 bar
max. operating temperature	100 °C
min. spec. density of fluid	0,75 kg/dm ³
weight at L1=500 mm	approx. 8 kg
weight L1 + 100 mm	approx. 0,2 kg

Material

float SK166	NBR
standpipe	1.4571
flange	steel galvanized
sight glass	PC
seal	brass nickered

Design

	0-AM	15-AM	25-AM
connector	pipe	flange	flange
flange DIN 2656		DN15	DN25
øD	20	95	115
øk		65	85
ød		14	14
b		16	18
øA		45	68
h		12	14

other designs on request

appropriate level contacts see on page 4

Option

transducer tube	-K continuous level	O P T I O N A L
measurement principle	reed contact	
resolution	5 or 10 mm	
operating voltage (U _B)	10 - 30 V DC	
output	4 - 20 mA (nominal voltage 24 V DC)	
load Ω max.	(U _B - 7,5 V) / 0,02 A	

Accessories:

Part No.	
22 51 000	flange gasket 45/22x2 mm (DN15)
22 52 000	flange gasket 68/27x2 mm (DN25)
22 71 999	fixing bolts 8 x M12x65

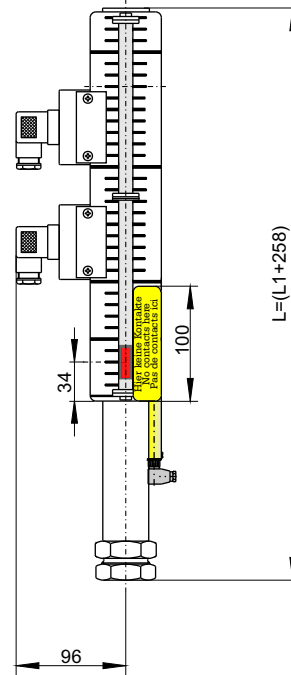
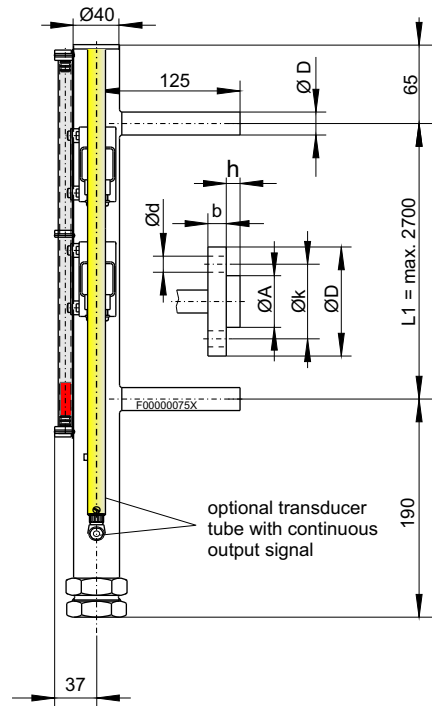

Product code for NS 10

NS 10/ -SK166/

Design

0-AM	with stub pipe
15-AM	flange DN 15
25-AM	flange DN 25

Length

L1 = ...mm

Option transducer tube

-K5	continuous resolution 5 mm	O P T. T.
-K10	continuous resolution 10 mm	

Example for order

You need: Level switch for the external mounting, operating pressure max. 10 bar, with flange connection DN15, distance of stub L1 = 1500 mm, with 2 change over contacts MKS - 1/W

You order: NS 10/15-AM-SK166 / 1500
2 x Part No. 288 99 99 contact MKS 1/W

Technical data

NS 25 ..-AM

Basic unit

operating pressure max.	25 bar	
operating temperature max.	120 °C	
spec. density of fluid min.	SK 661	SK 662
	0,85 kg/dm ³	0,70 kg/dm ³
weight at L1 = 500	approx. 9,5 kg	approx. 10,5 kg
weight L1+100 mm	approx. 0,4 kg	approx. 0,4 kg

Material

float	1.4571
standpipe	1.4571
flange	steel galvanized
sight glass	PC

Design

	15-AM	25-AM
connector	flange	flange
flange DIN 2656	DN15	DN25
øD	95	115
øk	65	85
ød	14	14
b	16	18
øA	45	68
h	12	14
S at float	SK 661	205205
	SK 662	390390

other designs on request

appropriate level contacts see on page 4

Option

transducer tube	-K continuous level	O P T I O N A L
measurement principle	reed contact	
resolution	5 or 10 mm	
operating voltage(U _B)	10 - 30 V DC	
output	4 - 20 mA (nominal voltage 24 V DC)	
load Ω max.	(U _B - 7,5 V) / 0,02 A	

Accessories

Part No.	Description
22 51 000	flange gasket 45/22x2mm (DN15)
22 52 000	flange gasket 68/27x2mm (DN25)
22 71 999	fixing bolts 8 x M12x65

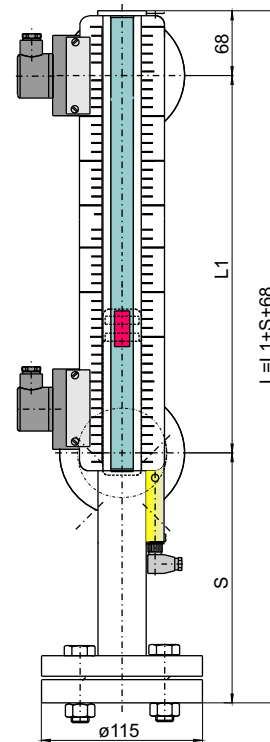
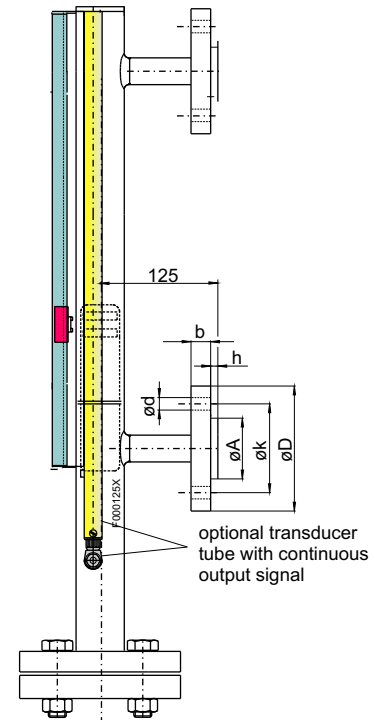

Product code for NS 25

NS 25/ [] [] [] / []

Design

15-AM flange DN 15
25-AM flange DN 25

O Option transducer tube
P **-K5** continuous resolution 5mm
T **-K10** continuous resolution 10mm

Length

L1 = ...mm

float type

-SK661 spec. density of fluid min. 0,85 kg/dm³
-SK662 spec. density of fluid min. 0,70 kg/dm³

Example for order

You need: Level switch for external mounting, operating pressure max. 25 bar, with flange connector DN25, spec. density of fluid 0,89 kg/dm³ stub distance L1 = 1500mm, continuous level output, resolution 10 mm and with 2 change over contacts MKS - 1/W (see on page 4)

You order: NS 25/25-AM-K10-SK661 / 1500
2 x Part No. 288 99 99 contact MKS - 1/W

Contacts for NS ..AM

Pin assignment (contact position empty reservoir) mounting left mounting right

Type	MKS-1/K
function	NC / NO
max. voltage	230 V AC/DC
max. current	1 A
max. load of contact	50 VA
connector	DIN EN 175301-803 (M3)
protection system	3 pol. + PE
Part No.	28 88 999

Type	MKS-2/K
function	2 x NC / NO
max. voltage	230 V AC/DC
max. current	1 A
max. load of contact	50 VA
connector	S6
protection system	6 pol. + PE
Part No.	28 91 999

Type	MKS-1/W
function	change over
max. voltage	230 V AC/DC
max. current	1 A
max. load of contact	50 VA
connector	DIN EN 175301-803 (M3)
protection system	3 pol. + PE
Part No.	28 89 999

Type	MKS-1/W-L 24 V
function	change over with LED
max. voltage	24 V DC
max. current	1 A
max. load of contact	50 VA
connector	S6
protection system	6 pol. + PE
Part No.	28 90 999

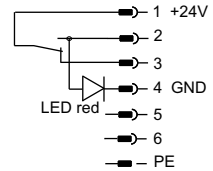
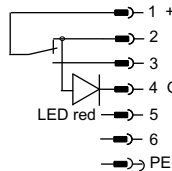
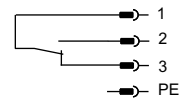
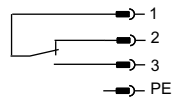
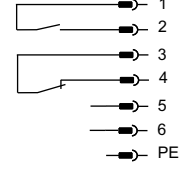
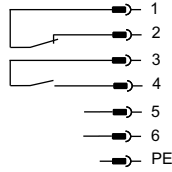
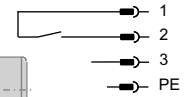
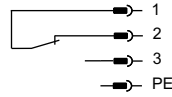

other contacts on request

For operations in areas with strong vibrations we suggest to use contacts MKS-1/K and MKS-2/K.

When mounting a transducer tube with continuous output signals you have to keep in mind that the mounting of contacts is possible only on the left side.

Pin assignment for AM-K with connector S3

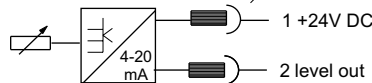

**MKS 1/K
MKS 1/W**

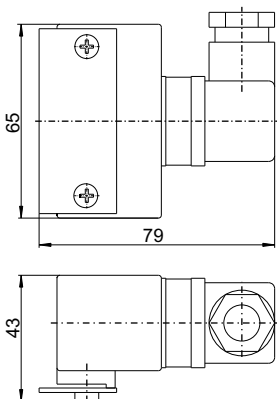

MKS 2/K

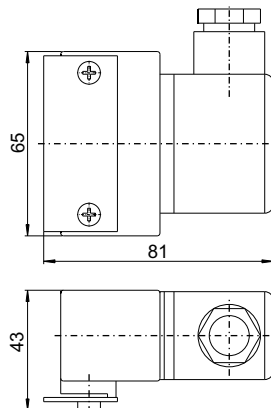

MKS 1/W-L24V

